



CITY OF SPRING LAKE PARK

Code Enforcement Department

1301 Eighty First Avenue Northeast

Spring Lake Park, Minnesota 55432

Ph: 763-784-6491 Fax: 763-792-7257

Website: www.slpmn.org

ROOFING – ASPHALT SHINGLES

All governing codes and noted sections are based on the 2020 Minnesota Residential Code

Permits

A permit is required to reroof a residence. Permits may be obtained by either the homeowner or a contractor who is licensed by the State of Minnesota. All contractors engaged in roofing work must have a state contractor's license and show proof of the license to obtain a permit. Specific questions regarding contractor licenses should be directed to the Minnesota Department of Labor and Industry, (651) 284-5069 or 1-800-342-5354.

INSPECTIONS

A final inspection will automatically be scheduled after the pictures have been received by the city.

Clear Digital Pictures are required:

- 1) All pictures must be in a clear **digital** format - no hard copies accepted. Hard copies must be converted to digital prior to submitting to the Building Department.
- 2) Pictures may be directly e-mailed to the City at jbaker@slpmn.org – please put the address and permit number in the email subject line.
- 3) CD's or USB cards may be dropped off at the Building Inspection Department. No final inspection approvals shall be made prior to receiving and viewing the roofing pictures.
- 4) The pictures shall include 1 (one) photograph each of the roof decking, all ice and water protection, all flashing details, all vents, a finished roof detail and the front of the house with address.

Final inspections are completed by site visit only. Access to fenced yards shall be planned.

GENERAL

This handout mainly addresses the requirements for asphalt and mineral surfaced roll roofing. Wood shingles, wood shakes, and steel shingles (minimum 26 gauge) are also permitted. Installation of these types of roofing must also comply with the City Ordinance, MN State Residential Code, and Manufacturer's Installation requirements.

All debris must be contained. Construction dumpsters are permitted on private property, driveways or yards during the permit period. Construction dumpsters are not permitted on any City street. To report violations please call the Police Non-Emergency number – 763-427-1212.

Permitted Hours of Construction: 7am to 10pm. To report violations please call the Police Non-Emergency number – 763-427-1212.

All roof covering materials must be delivered in packages bearing the manufacturers identifying marks and approved testing agency labels when required.

Roofing materials are to be installed in accordance with the manufacturers written installation instructions and 2020 Minnesota State Residential Code Chapter 9.

All asphalt shingles must be either self-sealing or interlocking.

Asphalt shingles may only be used on roof slopes of two units vertical in 12 units horizontal (2:12) or greater. For roof slopes from 2:12 to 4:12, double underlayment is required. Underlayment must conform to ASTM D 226, Type I; ASTM D 4869, Type I; or ASTM D 6757. For slopes of 4:12 and greater, underlayment must be applied shingle fashion. Laps must be a minimum of 2-inches. End laps must be offset by at least 6 inches.

For normal application, strip shingles must be fastened with a **minimum of four nails**. For interlocking shingles, two nails are required. See the manufacturer's installation instructions.

Valleys must be lined in accordance with the shingle manufacturers written instructions. In addition, valleys may be of any of the following:

- For open valleys lined with metal, the valley lining must be at least 24 inches wide and of galvanized steel of at least 26 gage or other approved materials.
- For open valleys, two plies of roll roofing may be permitted. The bottom layer must be at least 18 inches wide and the top layer at least 36 inches wide.
- For closed valleys (valleys covered with shingles), valley lining of one ply of smooth roll roofing complying with ASTM D 224 Type II or Type III and at least 36 inches wide or one of the two methods previously listed may be used.

Roof decks must be solidly sheathed for asphalt shingles or mineral-surfaced roll roofing. Solid sheathing may be plywood, OSB, or 1-inch nominal boards. Wood shingles and shakes may be applied over solid or spaced sheathing. Roof decks that are rotted or unsound must be repaired prior to reroofing (Site inspection or digital pictures of repairs will be required). Reroofing only portions of a roof is permitted (including hail damage situations).

REROOFING, OVERLAYS, & PARTIAL ROOFING

Any sheathing that is replaced must be installed and fastened according to the code. Where the existing roof assembly includes an ice barrier membrane that is adhered to the roof deck, it shall be permitted to remain in place and covered with an additional layer of ice barrier membrane (for a maximum of two layers).

It is permitted to apply roofing over one existing layer of asphalt shingles (if considered a flat and adequate base). It is also permitted to replace independent sections/portions of roof covering without replacing the entire roof covering of the home. In addition to the MN Residential Building Code requirements, the manufacturer's installation requirements must be met.

ICE AND WATER BARRIER

An ice and water barrier is required on all roofs except for detached accessory buildings (garages). The barrier may be at least two layers of underlayment cemented together or a self-adhering polymer modified bitumen sheet. There are several manufacturers who make materials specifically for this requirement that are marketed under differing trade names. The ice and water barrier must extend from the edge of the eaves to a point **24 inches** inside the exterior wall line of the building. Ice and water barriers are required full-length in valleys (see picture on page 4 of this handout). The above noted ice and water protection requirements pertain to conditioned and unconditioned spaces. Ice and water protection is required on all attached garages. **EXCEPTION:** Detached accessory structures that contain no conditioned floor area.

A maximum of two layers is permitted, however, if the manufacturer does not permit a second layer, the existing ice and water barrier would need to be removed and replaced.

UNDERLAYMENT

Underlayment shall be applied shingle fashion, parallel to and starting from the eave and lapped 2 inches (51mm), fastened sufficiently to hold in place. End laps shall be offset by 6 feet (1829mm).

VENTILATION

Enclosed attics and enclosed rafter spaces formed where ceilings are applied directly to the underside of roof rafters shall have cross ventilation for each separate space by ventilating openings protected against the entrance of rain or snow. Any garage with an enclosed attic space shall be ventilated.

Ventilation Area - Ventilation of enclosed attics and enclosed rafter spaces is required. Ventilating openings must be provided with corrosion-resistant mesh with openings of $\frac{1}{16}$ " to $\frac{1}{4}$ " inch.

For attics without ceiling vapor barriers, 1 square foot of net free ventilating area should be provided for each 150 square feet of attic area.

For attics with vapor barriers or without ceiling vapor barriers and having at least 50% but not more than 80% of the ventilating area provided by ventilators located in the upper portion of the space to be ventilated and at least 3 feet above the eave vents and the balance of the ventilation provided in the eave vents, ventilation may be 1 square foot of net free ventilating area for each 300 square feet of attic area.

Vent Clearance. Where eave or cornice vents are installed, insulation shall not block the free flow of air. A minimum of a 1-inch space shall be provided between the insulation and the roof sheathing at the location of the vent.

Ridge vents and gable louvered vents, installed per manufacturer's installation instructions, are acceptable alternatives.

FLASHING (see drawings on page 4 and 5 of this handout)

Flashing is required at all wall and roof intersections, wherever there is a change in roof slope or direction, and around roof openings. When flashing is metal, it must be corrosion resistant metal with a thickness of not less than 0.019 inch (No. 26 galvanized sheet) (R903.2.). When re-roofing missing, rusted or damaged flashing and counter-flashing, vent caps, and metal edging shall be installed or replaced with new materials. Flashing against vertical front walls, soil stacks, vent pipes, and chimney flashing must be in accordance with the asphalt shingle manufacturer's printed instructions. Sidewall flashing shall be by the step flashing method and is required whenever wall and roof intersections occur.

Kick-out flashing, when installed, is where the lower portion of a sloped roof stops within the plane of an intersecting wall cladding, in such a manner as to divert or kick out water away from the assembly. Kick-out flashing may be either factory made or field fabricated and a minimum of 2 $\frac{1}{2}$ " long & 26 gauge. Kick-out flashing is required when both roofing and siding are replaced.

Crickets or saddles are required on the ridge side of any chimney greater than 30 inches wide. Cricket or saddle coverings must be of sheet metal or of the same material as the roof covering.

FASTENERS (see picture page 5 of this handout)

Fasteners shall be long enough to penetrate the sheathing $\frac{3}{4}$ " or through the thickness of the sheathing, whichever is less. Fasteners shall comply with the following; corrosion resistant nails, minimum 12 gauge 3/8" head, per ASTM F 1669. (galvanized steel, stainless steel, aluminum or copper).

Use the recommended number of fasteners and placement according to the manufacturers written installation instruction. Fasteners shall be installed perpendicular to the roof sheathing and not penetrate the shingle surface.

FASTENER SCHEDULE FOR ROOFING			
Asphalt Shingles	Mineral-surfaced Roll Roofing	Wood Shingles	Wood Shakes
Fasteners for asphalt shingles must be galvanized steel, stainless steel, aluminum, or copper roofing nails, minimum 12 gauge shank with a minimum 3/8" diameter head and of a length to penetrate through the roofing materials and a minimum of 3/4" inch into roof sheathing or when roof sheathing is less than 3/4" thick, the fastener shall penetrate through the sheathing.	Roll roofing must be installed in accordance with the manufacturer's installation instructions.	Fasteners for wood shingles must be corrosion-resistant with a minimum penetration of 1/2" into the sheathing. For sheathing less than 1/2" in thickness, the fastener shall extend through the sheathing. A minimum of two fasteners per shingle are required.	Fasteners for wood shakes must be corrosion-resistant with a minimum penetration of 1/2" into the sheathing. For sheathing less than 1/2" in thickness, the fastener shall extend through the sheathing. A minimum of two fasteners per shake are required.

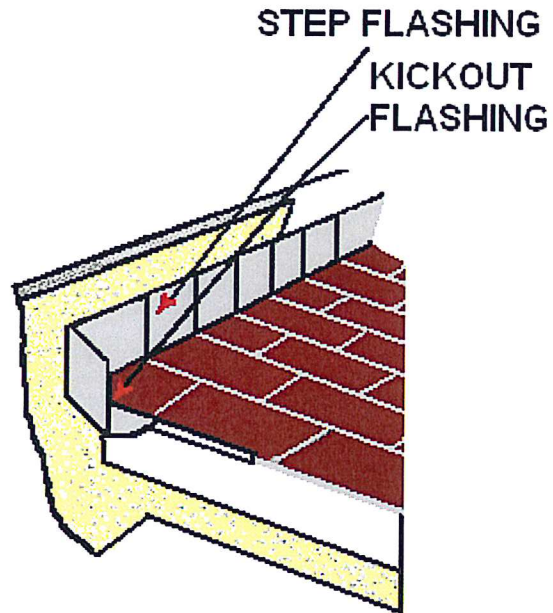
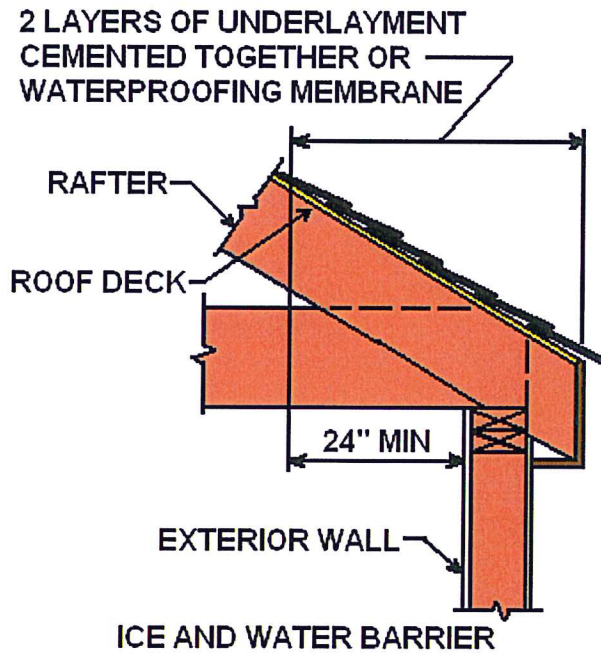

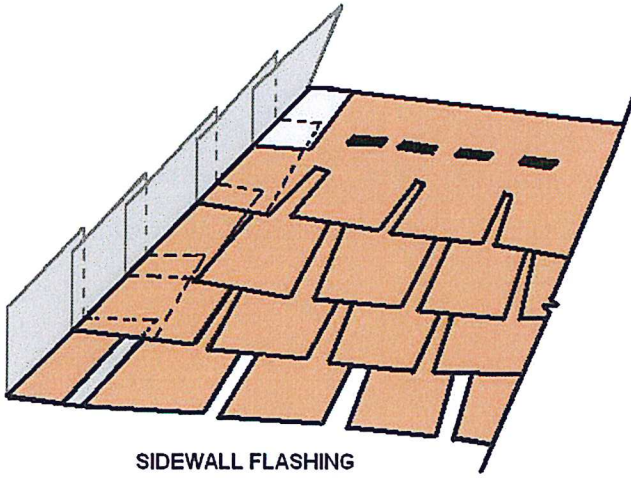

SIDEWALL FLASHING

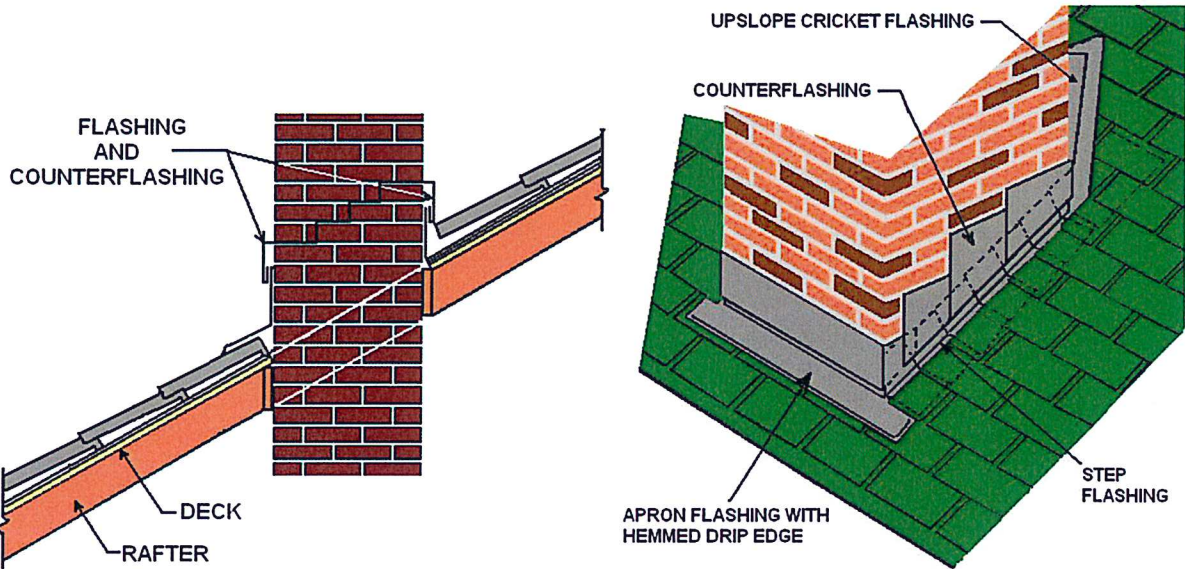

Sidewall flashing (26-Gauge)

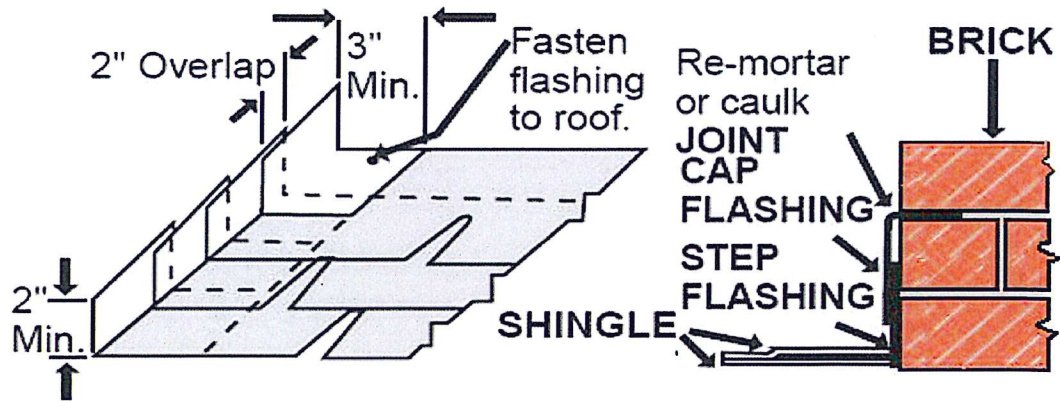

Cricket or Saddle required if chimney is more than 30 inches wide

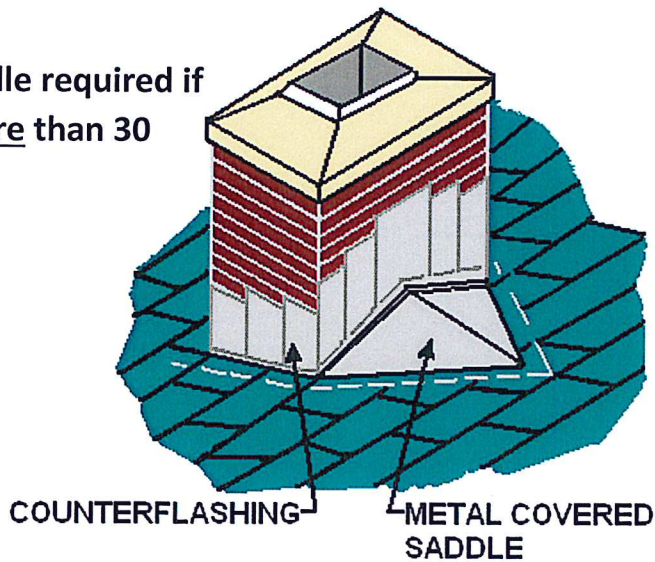

MINERAL SURFACED ROLL ROOFING - R905.5

Mineral surfaced roll roofing may only be applied on roofs with a slope of 1:12 or greater. Mineral surface roll roofing must conform to ASTM D 3909 or ASTM D 6380, Class M. Mineral surface roll roofing must be installed in accordance with the manufacturer's installation instructions.

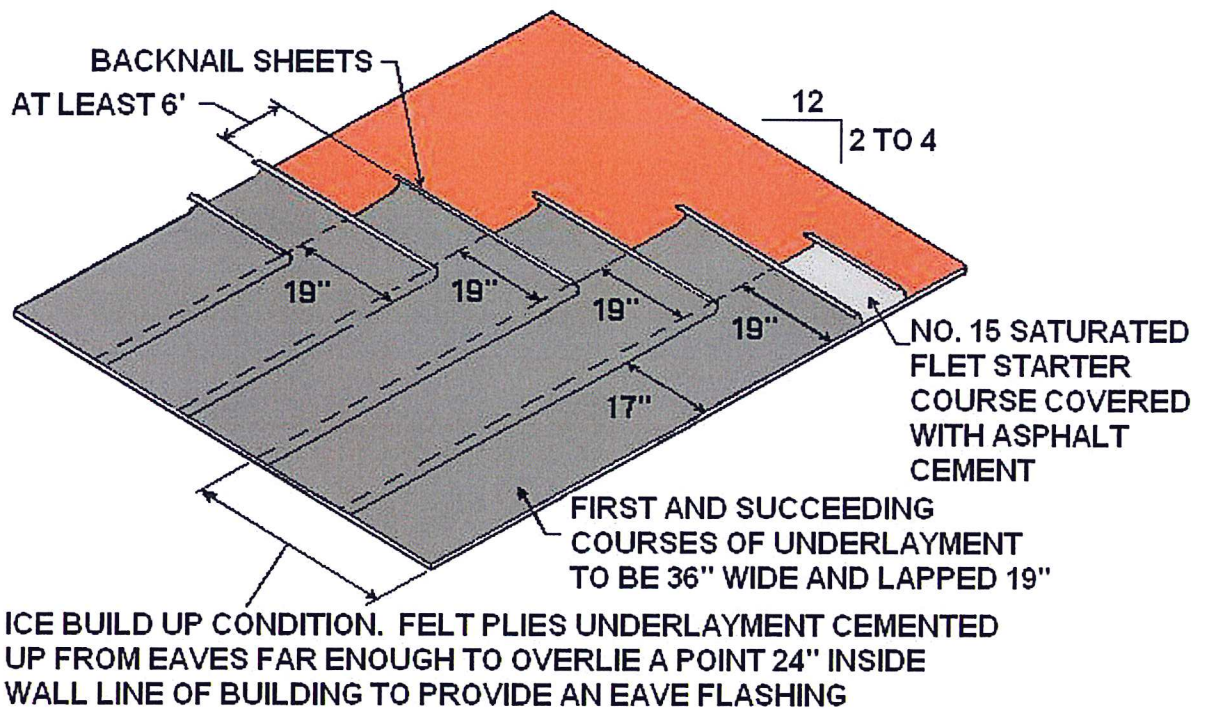



CITY of SPRING LAKE PARK

1301 Eighty First Avenue Northeast
 Spring Lake Park, Minnesota 55432
 Ph: (763) 784-6491 Fax: (763) 792-7257
 Website: www.slpmn.org

ROOF VENTILATION WORK SHEET

STEP 1: Determining Roof Area:

Roof area is determined by a flat, one dimensional area. There is no need to calculate cubic area or the numbers of squares. Only calculate conditioned spaces including attached garages. (Length in Feet x Width in feet = Area in square feet)

Area A: Length (ft) _____ x's Width (ft) _____ = _____ Square Feet.

Area B: Length (ft) _____ x's Width (ft) _____ = _____ Square Feet.

Area C: Length (ft) _____ x's Width (ft) _____ = _____ Square Feet.

Total Roof Area: _____ Square Feet.

STEP 2: Determining Existing Roof Conditions:

Does the existing roof have soffit vents or gable end vents? This will determine the amount of ventilation required on the roof to meet code. (Look under the roof overhang or at the top of the triangular wall on a gable roof)

- The Existing Roof **does not** have Soffit Vents.
- The Existing Roof **does** have Soffit Vents.
- The Existing Gable End **does not** have Vents.
- The Existing Gable End **does** have Vents.

STEP 3: Determining Method of Venting Area Required:

Depending on the existing or non-existing ventilation checked on Step 2, determine the amount of roof ventilation area required.

- The Existing Roof **does not** have Gable and/or Soffit Vents:

Step 1 Area _____ (Sq. Ft.) Divided by 150 = _____ (Sq. Ft.) Total Roof Ventilation Area Required.

- The Existing Roof **does** have Gable and/or Soffit Vents:

Step 1 Area _____ (Sq. Ft.) Divided by 300 = _____ (Sq. Ft.) Divided by 2 = _____ (Sq. Ft.)
 Total Roof Ventilation Area Required.

STEP 4: Determining Number of Venting Fixtures:

By taking the total roof ventilation area required in Step 3, determine the number of venting fixtures required on the roof.

- Roof Louvers: Step 3 _____ Vent. Area (Sq. Ft.) Divided by .416 = _____ Louvers Required.
- Turbines: Step 3 _____ Vent Area (Sq. Ft.) Divided by 4 = _____ Turbines Required.
- Ridge Vents: Step 3 _____ Vent Area (Sq. Ft.) Times by 8.3 = _____ Feet of Ridge Required.

I hereby testify that the above calculations are true and accurate. I have verified that any and/or all existing ventilation fixtures are in good operating order, free from obstructions, and function fully as required.

 Roofing Contractor/Homeowner Signature

 State License Number (If Applicable)

 Date



City of Spring Lake Park - Code Enforcement

1301 81st Avenue NE • Spring Lake Park MN 55432 • Phone: 763-784-6491 • Fax: 763-792-7257 • www.slpmn.org



BUILDING PERMIT APPLICATION

Job Address _____

Property Owner

Name _____

Address _____ Phone _____

Email _____

Contractor

Name _____

Address _____ Phone _____

Email _____

State License # _____ Exp. Date _____ Lead Cert. Date _____
dd/mm/yr dd/mm/yr

Applicant Same as Property Owner Contractor

Name _____

Address _____ Phone _____

Email _____

Describe Work _____

Value of Work Including Labor _____ Start Date _____ Estimated Completion Date _____
dd/mm/yr dd/mm/yr

Commercial/Industrial *Submit two plan sets and specifications for commercial or industrial work.*

Describe Building Use and/or Changes in Use _____

Notice

Separate permits are required for electrical, plumbing, heating, ventilating, and air conditioning. This permit becomes null and void if work or construction authorized is not commenced within 180 days or work is suspended or abandoned for a period of 180 days at any time after work is commenced.

I hereby certify that I have read and examined this application and know the same to be true and correct. All provisions of laws and ordinances governing this type of work will be complied with whether specified herein or not. The granting of a permit does not presume to give authority to violate or cancel the provisions of any other State or local law regulating construction or the performance of construction. Initial here _____

➡ Contractor Signature _____ Date of Application _____
dd/mm/yr

➡ Homeowner Doing Work in Homestead Signature _____ Date of Application _____
dd/mm/yr

If application is not fully completed, it will be denied at time of processing. Please verify that all necessary information is legible and plans are included with job cost estimates. Contact Permit Technician to verify all necessary information is provided before submitting.

Payment: *We accept cash, checks payable to City of Spring Lake Park, or credit cards (with additional processing fees), at the front counter only.*



City of Spring Lake Park - Code Enforcement

1301 81st Avenue NE • Spring Lake Park MN 55432 • Phone: 763-784-6491 • Fax: 763-792-7257 • www.slpmn.org



BUILDING PERMIT APPLICATION

Building Permit Applicant: Property Owner

I understand that the State of Minnesota requires that all residential building contractors, remodelers and roofers obtain a state license unless they qualify for a specific exemption from the licensing requirements. By signing this document, I attest to the fact that I am building or improving this house myself. I hereby claim to be exempt from the state licensing requirements because I am not in the business of building on speculation or for resale and that the house for which I am applying for this permit, located at

_____ is the first residential structure I have built or improved the past twenty-four (24) months. I also acknowledge that because I do not have a state license, I forfeit any mechanic's lien rights to which I may otherwise have been entitled under Minnesota Statute 514.01. In the event that I do construct or improve another residential structure in the next 24 months, I will not do so until I obtain the required state license, per Minnesota Statute 326.84, understanding that failure to do so is a misdemeanor under state law.

Furthermore, I acknowledge that I may be hiring independent contractors to perform certain aspects of the construction or improvement of this house and I understand that some of these contractors may be required to be licensed by the State of Minnesota. I understand that unlicensed residential contracting; remodeling and/or roofing activity is a misdemeanor under Minnesota Statute 326.92, subdivision 1, and that I would forfeit my rights to reimbursement from the Contractor's Recovery Fund in the event that any contractors I hire are unlicensed.

I also acknowledge that as the contractor on this project, I am solely and personally responsible for any violations of the state building code and/or city ordinance in connections with the work performed on this property.

Signature of Property Owner

Date dd/mm/yr